

ALFATECH

IMPIANTI E SISTEMI DI SOLLEVAMENTO

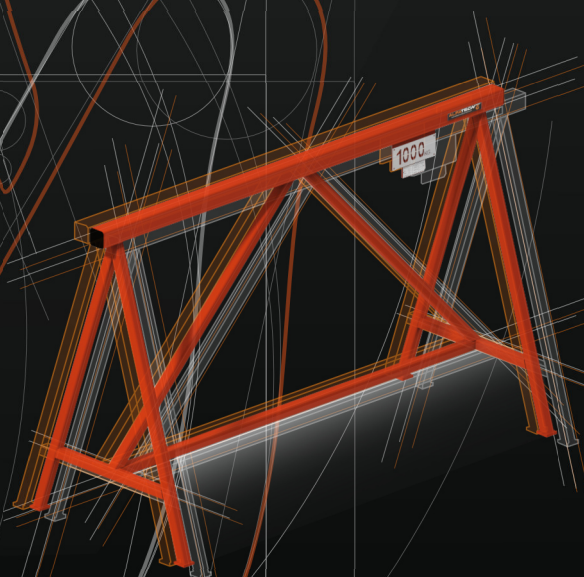

CAVALLETTI

CATALOGO

ALFATECHSOLLEVAMENTO.COM

CHI SIAMO



ALFATECH s.r.l. azienda leader nel settore dei sistemi di sollevamento, presente sul mercato nazionale ed internazionale da 20 anni, e grazie all'esperienza pluriennale continua con professionalità a portare avanti il suo ideale di affidabilità ed efficienza grazie ad un team altamente qualificato e specializzato in prototipazione, costruzione, montaggio e assistenza.

Grazie alla passione e alla completa dedizione del titolare, che trasmette ogni giorno al proprio team, l'azienda è cresciuta maturando negli anni un know-how tale da poter analizzare e risolvere ogni necessità e richieste dei clienti.

La nostra esperienza e dedizione viene resa disponibile al fine di rendere gli impianti sempre efficienti e soprattutto sicuri per il cliente.

Qualunque sia la tipologia di lavoro da eseguire o da progettare, lo staff è sempre alla ricerca della soluzione più adeguata, in modo tale che l'operatore venga messo nelle migliori condizioni a livello lavorativo.

L'ufficio tecnico/commerciale è il cuore pulsante nell'attività di progettazione e costruzione, sempre attento alle richieste del cliente, con la giusta determinazione riesce sempre a fornire un prodotto adeguato all'esigenza richiesta fin nei minimi dettagli, per il raggiungimento del prodotto ideale.

Le costruzioni standard, la base di partenza dei nostri prodotti, possono essere modificate e personalizzate sia in dimensioni che portate, garantendo una massima qualità e sicurezza, grazie alla notevole competenza dei nostri uffici interni sia tecnico che commerciale.

Lo staff vanta figure con esperienze pluriennali nel settore, è sempre pronto ad offrire un totale e completo servizio, non solo con i prodotti progettati e costruiti al proprio interno, ma offre anche assistenza in caso di anomalie, reperendo accessori e ricambi dove necessario.

Alfatech offre anche una gamma di servizi come manutenzioni periodiche programmate degli impianti di sollevamento di qualsiasi marca e fattezza come richiesto dalle normative vigenti.

Alfatech dispone di uno staff completo anche per quanto concerne le attività di montaggi, spostamenti, revamping, verifiche di tipo decennale o ventennale su qualsiasi tipologia di gru.

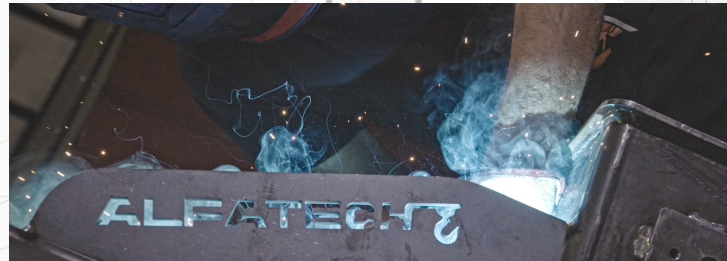
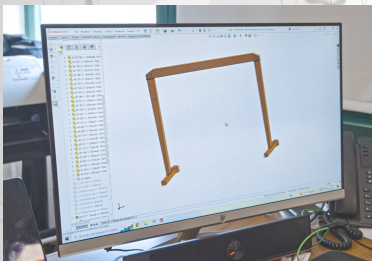

PROGETTAZIONE - ASSISTENZA - VENDITA - PRODUZIONE - MONTAGGI - RIPARAZIONI

ALFATECHSOLLEVAMENTO.COM - Tel 0549-904088 - info@alfatechsollelamento.com



CAVALLETTO STANDARD

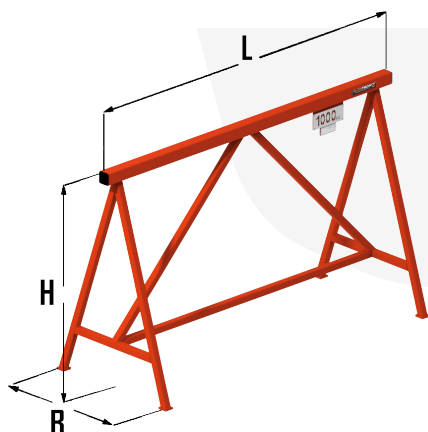

TIPO	Portata Kg.	L (mm.)	H (mm)	B (mm.)
A CA 0,2	200	1.200	900	600
A CA 0,5	500	1.200	900	600
A CA 1	1.000	1.500	900	600
A CA 2	2.000	1.500	900	600
A CA 3	3.000	1.500	900	600
A CA 4	4.000	1.500	900	600
A CA 5	5.000	1.500	900	600
A CA 6	6.000	1.500	900	600
A CA 7	7.000	1.500	900	600
A CA 8	8.000	1.500	900	600
A CA 9	9.000	1.500	900	600
A CA 10	10.000	1.500	900	600
A CA 11	11.000	1.500	900	600
A CA 12	12.000	1.500	900	600
A CA 13	13.000	1.500	900	600
A CA 14	14.000	1.500	900	600
A CA 15	15.000	1.500	900	600

* Cavalletti con misure e portate diverse dallo standard saranno quantificati a disegno

CAVALLETTO CON RUOTE SEMIAUTOMATICHE



POSIZIONE DI TRASPORTO



POSIZIONE DI LAVORO

TIPO	Portata Kg.	L (mm.)	H (mm.)	B (mm.)
A CA 0,2 R	200	1.200	900	600
A CA 0,5 R	500	1.200	900	600
A CA 1 R	1.000	1.500	900	600
A CA 2 R	2.000	1.500	900	600
A CA 3 R	3.000	1.500	900	600
A CA 4 R	4.000	1.500	900	600
A CA 5 R	5.000	1.500	900	600
A CA 6 R	6.000	1.500	900	600
A CA 7 R	7.000	1.500	900	600
A CA 8 R	8.000	1.500	900	600
A CA 9 R	9.000	1.500	900	600
A CA 10 R	10.000	1.500	900	600
A CA 11 R	11.000	1.500	900	600
A CA 12 R	12.000	1.500	900	600
A CA 13 R	13.000	1.500	900	600
A CA 14 R	14.000	1.500	900	600
A CA 15 R	15.000	1.500	900	600

*Il posizionamento del cavalletto viene mediante una leggera pressione verso l'alto o verso il basso in base all'utilizzo

*N.4 ruote pivotanti comprese

CAVALLETTO CON RUOTE



TIPO	Portata Kg.	L (mm.)	H (mm.)	B (mm.)
A CA 0,2 RU	200	1.200	900	600
A CA 0,5 RU	500	1.200	900	600
A CA 1 RU	1.000	1.500	900	600
A CA 2 RU	2.000	1.500	900	600
A CA 3 RU	3.000	1.500	900	600
A CA 4 RU	4.000	1.500	900	600
A CA 5 RU	5.000	1.500	900	600
A CA 6 RU	6.000	1.500	900	600
A CA 7 RU	7.000	1.500	900	600
A CA 8 RU	8.000	1.500	900	600
A CA 9 RU	9.000	1.500	900	600
A CA 10 RU	10.000	1.500	900	600

* N.4 ruote pivotanti comprese

CAVALLETTO CON TIMONE E RUOTE



POSIZIONE DI TRASPORTO



POSIZIONE DI LAVORO

TIPO	Portata Kg.	L (mm.)	H (mm)	B (mm.)
A CA 0,2 T	200	1.200	900	600
A CA 0,5 T	500	1.200	900	600
A CA 1 T	1.000	1.500	900	600
A CA 2 T	2.000	1.500	900	600
A CA 3 T	3.000	1.500	900	600
A CA 4 T	4.000	1.500	900	600
A CA 5 T	5.000	1.500	900	600
A CA 6 T	6.000	1.500	900	600
A CA 7 T	7.000	1.500	900	600
A CA 8 T	8.000	1.500	900	600
A CA 9 T	9.000	1.500	900	600
A CA 10 T	10.000	1.500	900	600
A CA 11 T	11.000	1.500	900	600
A CA 12 T	12.000	1.500	900	600
A CA 13 T	13.000	1.500	900	600
A CA 14 T	14.000	1.500	900	600
A CA 15 T	15.000	1.500	900	600

- * Ruote fisse laterali con piastra di fissaggio (n.2 pz)
- * Timone di manovra richiudibile
- * Manopole di rivestimento antiscivolo

CAVALLETTO CON PIEDINI REGOLABILI



ESTENSIONE MINIMA



ESTENSIONE MASSIMA

TIPO	Portata Kg.	L (mm.)	H (mm)	B (mm.)
A CA 0,2 PR	200	1.200	800/900	600
A CA 0,5 PR	500	1.200	800/900	600
A CA 1 PR	1.000	1.500	800/900	600
A CA 2 PR	2.000	1.500	800/900	600
A CA 3 PR	3.000	1.500	800/900	600
A CA 4 PR	4.000	1.500	800/900	600
A CA 5 PR	5.000	1.500	800/900	600
A CA 6 PR	6.000	1.500	800/900	600
A CA 7 PR	7.000	1.500	800/900	600
A CA 8 PR	8.000	1.500	800/900	600
A CA 9 PR	9.000	1.500	800/900	600
A CA 10 PR	10.000	1.500	800/900	600
A CA 11 PR	11.000	1.500	800/900	600
A CA 12 PR	12.000	1.500	800/900	600
A CA 13 PR	13.000	1.500	800/900	600
A CA 14 PR	14.000	1.500	800/900	600
A CA 15 PR	15.000	1.500	800/900	600

- * Escursione standard 100 mm.
- * Piedino svitabile ed estraibile in caso di necessità
- * Regolazione con chiave

CAVALLETTO REGOLABILE IN ALTEZZA



ESTENSIONE MINIMA



ESTENSIONE MASSIMA

TIPO	Portata Kg.	L (mm.)	H (mm)	B (mm.)
A CA 0,2 RH	200	1.200	750/1200	600
A CA 0,5 RH	500	1.200	750/1200	600
A CA 1 RH	1.000	1.500	750/1200	600
A CA 2 RH	2.000	1.500	750/1200	600
A CA 3 RH	3.000	1.500	750/1200	600
A CA 4 RH	4.000	1.500	750/1200	600
A CA 5 RH	5.000	1.500	750/1200	600
A CA 6 RH	6.000	1.500	750/1200	600
A CA 7 RH	7.000	1.500	750/1200	600
A CA 8 RH	8.000	1.500	750/1200	600
A CA 9 RH	9.000	1.500	750/1200	600
A CA 10 RH	10.000	1.500	750/1200	600
A CA 11 RH	11.000	1.500	750/1200	600
A CA 12 RH	12.000	1.500	750/1200	600
A CA 13 RH	13.000	1.500	750/1200	600
A CA 14 RH	14.000	1.500	750/1200	600
A CA 15 RH	15.000	1.500	750/1200	600

SUPPLEMENTI



- Rivestimento su base d'appoggio con gomma tipo da banco (spessore 4 mm.) incollata



- Rivestimento su base d'appoggio con legno (tipo marino spessore 5 mm.) incollato



- Battute laterali antirotolamento del materiale fuori dal cavalletto (H 50 mm.)



- Angolare su base d'appoggio (consigliato per cavalletti destinati all'ambito della verniciatura)

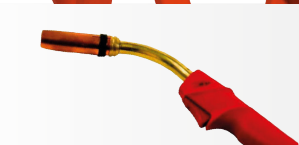

- Accessorio porta torcia per saldatrice



- Accessorio porta smerigliatrice



- Accessorio con battute laterali antirotolamento materiale
- Accessorio con rivestimento in gomma tipo da banco (spessore 4 mm.)
- Accessorio con rivestimento in legno (tipo marino spessore 5 mm.)
- Accessorio con angolare saldato nella parte superiore

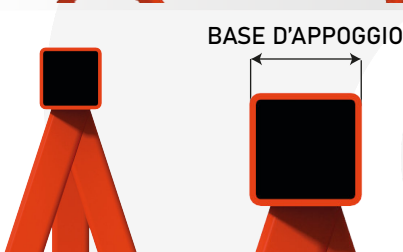

- Base d'appoggio maggiorata

INFORMAZIONI GENERALI



- Il cavalletto è dotato di targhetta in alluminio con matricola, anno di costruzione, modello, peso proprio e portata massima
- Il cavalletto è dotato di ulteriore targhetta di portata
- Colore RAL standard arancio - (A richiesta RAL personalizzato)

DOCUMENTAZIONE

- **MANUALE DI USO E MANUTENZIONE**
- CERTIFICATO "UE" costruito in conformità dei seguenti standard:
 - **EN 12100:2010** (Sicurezza del macchinario)
 - **UNI EN 10025-2:2019** (Prodotti laminati a caldo di acciai per impieghi strutturali - Parte 2)
 - **CNR 10011/97** (Costruzioni in acciaio)
- **CLASSIFICAZIONE CAVALLETTO: elementi strutturali GRUPPO A5**

PROGETTAZIONE - ASSISTENZA - VENDITA - PRODUZIONE - MONTAGGI - RIPARAZIONI

REALIZZAZIONE CAVALLETTI A DISEGNO

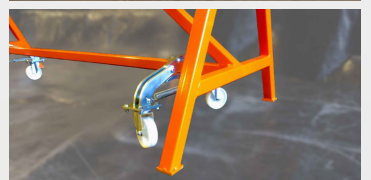
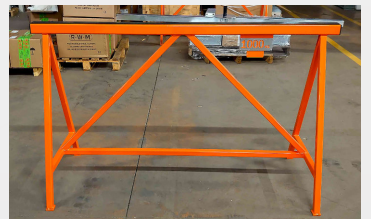

SOLLEVAMENTO



Gru a Bandiera a Colonna con braccio in canalina



Gru a Bandiera a Rotazione Elettrica 360°



Gru a Bandiera a Mensola con braccio in trave tirantata

GRU A BANDIERA



Gru a Bandiera a Colonna in Trave Rovescia



Gru a Bandiera a colonna con Bracci Contrapposti (una colonna con due bracci)



Gru a Bandiera a Mensola a Rotazione Motorizzata

GRU A PONTE

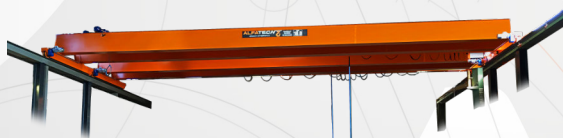

Gru a Ponte Bitrave



Gru a Ponte Monotrave

GRU A PORTALE



Gru a Portale Motorizzata su binario



Gru a Portale fissa



Gru a Portale Telecomandata



Gru a Portale Regolabile in altezza



Gru a Portale Regolabile in altezza con Paranchi manuali a catena



Gru a Portale "Alufer"

PROGETTAZIONE - ASSISTENZA - VENDITA - PRODUZIONE - MONTAGGI - RIPARAZIONI

ALFATECHSOLLEVAMENTO.COM - Tel 0549-904088 - info@alfatechsollevamento.com



SOLLEVAMENTO

IMPIANTI SOSPESI IN CANALINA



MONOROTAIE

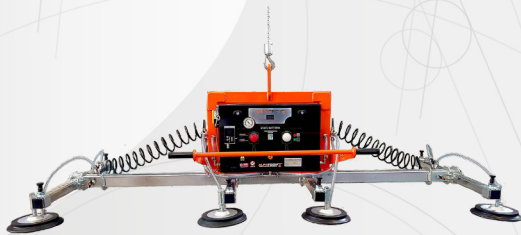
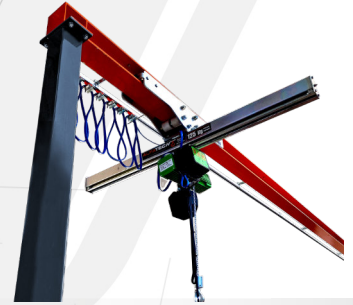
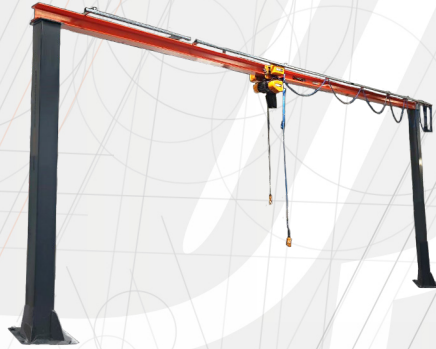

Ventosa per Lamiera



Ventosa per Vetro



Ventosa per Infissi



Ventosa per Pannelli Sandwich



Ventosa per Marmo

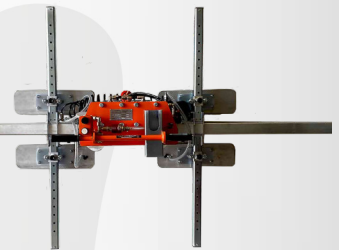

Ventosa per Legno

VENTOSE



Ventosa per Pannelli Coibentati

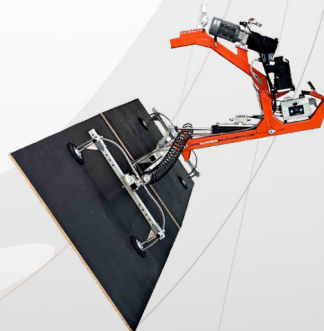

Ventosa Basculamento 180°



Ventosa per Scatole

SOLLEVAMENTO

VENTOSE INFORCABILI

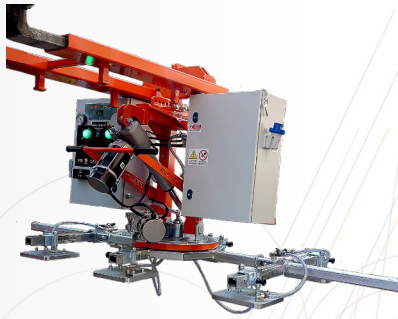

Ventosa Generica

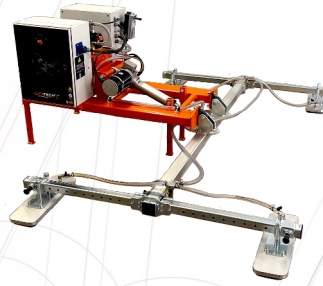

Ventosa per Legno

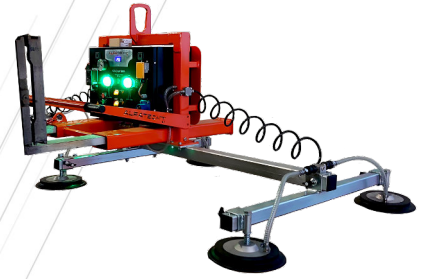

Ventosa per Lamiera

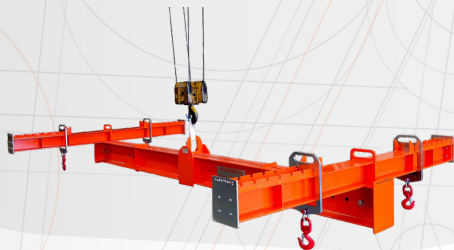

Bilancino ad H con Ganci Regolabili



Bilancino a Ganci Regolabili



Bilancini Big Bag

BILANCINI



Distanziale a Ganci Regolabili

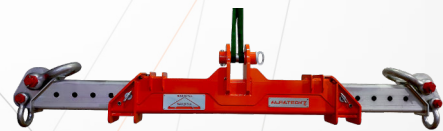

Bilancino / Distanziale Telescopico

INFORCABILI



Inforcabile Telescopico



Inforcabile Calzatoie Lunghe



Inforcabile Braccio Alto



Bilancino Inforcabile



Inforcabile Big Bags

PROGETTAZIONE - ASSISTENZA - VENDITA - PRODUZIONE - MONTAGGI - RIPARAZIONI

ALFATECHSOLLEVAMENTO.COM - Tel 0549-904088 - info@alfatechsolllevamento.com



SOLLEVAMENTO

GANCI PER COILS



PINZE



Pinza per interni

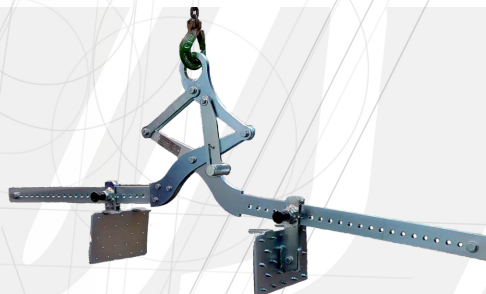

Pinza per scatole



Pinza per Bombole



Pinza per Rotori

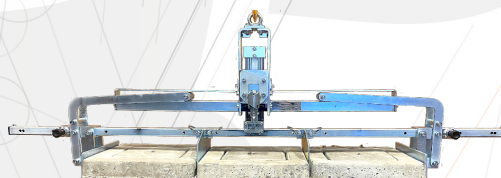

Pinza per Chiusini cementati



Pinza per Pozzetti cementati



Pinza per Lingotti

MANIPOLATORI FORZA ZERO

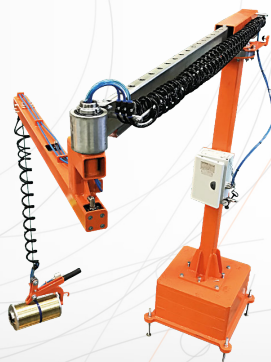

PRODOTTI COMMERCIALI



Golfari



Ganci



Radiocomandi



Pinze per lamiera



Magneti



Grilli, Tenditori, Capicorda, Morsetti, Redance, Calze, Campanelle



Tiranti



Forche per pallets

PROGETTAZIONE - ASSISTENZA - VENDITA - PRODUZIONE - MONTAGGI - RIPARAZIONI

ALFATECHSOLLEVAMENTO.COM - Tel 0549-904088 - info@alfatechsollevamento.com



APPOGGIO



Cavalletto Standard



Cavalletto con Piedini Regolabili



Cavalletto Regolabile in Altezza

CAVALLETTI



Cavalletto con Ruote e Timone



Cavalletto con Ruote Semiautomatiche



Cavalletto con Ruote

CESTONI



CARRELLI



CARRIARMATI

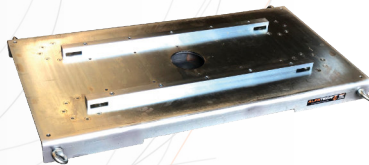

BANCHI DA LAVORO

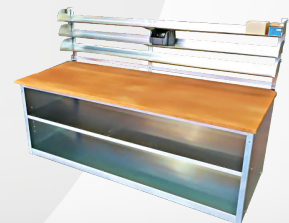

ALFATECH 
IMPIANTI E SISTEMI DI SOLLEVAMENTO

Strada dell'Assenzio 6 - Repubblica di San Marino
(RSM)

Tel/Fax 0549-904088
info@alfatechsollevarmento.com

CATALOGO

ALFATECHSOLLEVAMENTO.COM